

Keyless Entry



We take the worry out of
protecting what's valuable to you.
Lockwood: *no worries*[®]

LOCKWOOD

ASSA ABLOY

25YEAR

**MECHANICAL
WARRANTY**

www.lockweb.com.au

Contents



Keyless Entry

Lockset Nexion

page 3



Keyless Electronic

Deadlatch 001 Touch™

page 8



Keyless Electronic

Deadbolt

page 11



Wireless Electronic

Deadbolt

page 14



Code Handle

Left & Right Handed Keyless
Lockset

page 18



002 Digital DX

Deadlatch

page 20



530 Digital DX

Entrance Set

page 22



Mortice Digital DX

Lockset

page 24



Digital DX Lockset

3582, 3592 Short Backset

page 26



Digital DX Lockset

3572 Key Override

page 28



Digital DX Lockset

3572 Key Override Code
Lockout

page 30

Nexion® Keyless Entry Lockset - Vision



Description

This stylish lockset combines the security of an automatic deadlatch with added safety features, plus the convenience of keyless operation using the Q-Key remote control.

Designed and manufactured to the highest quality standard, the Lockwood Nexion range has set the benchmark for safety, security and style. The Nexion range of deadlatches offers the ultimate protection for your home and family.

Remote Operation Convenience

- 3 meter range keyless operation with Q-Key remote control
- Use same remote with multiple Nexion Keyless Entry Locksets
- Up to 50 Q-Key remotes can be programmed
- Provides audio and visual indication of lock activation and deactivation

Key Override

Mechanical override key and low battery indicator system.

Product Details

| | |
|-----------------------|---|
| Backset | 60mm standard and 70mm backset latch available as an accessory on some models |
| Batteries | 4 AA Alkaline batteries |
| Case/Cover | High Purity Zinc Alloy |
| Cylinders | Internal and external, 5 pin tumbler mechanism with 6 pin capability, brass cylinders and brass barrels |
| Door Thickness | 35 to 45mm |
| Durability | D8-High durability for maximum frequency usage |
| Finishes | Gold (GLD)* Satin Chrome (SC)# Satin Chrome Pearl (SP) Chrome Plate (CP) |
| Latch | 13mm projection brass bolt |
| Security | S:7 High security for maximum protection (AS4145.2-2008) |

* Classic Plate Only
Vision Plate Only

Standards and Compliance



The locksets can be optioned to suit fire door sets with a fire resistance level of up to 1 hour on fire door assemblies in accordance with Australian Standard AS1905.1:2005 Fire Resistant Doorsets. These locksets are optioned by substituting NX to NF in the part number. The NF series comes complete with all components required and is suitable for door thicknesses 35mm to 45mm. For doors 46mm to 50mm, a longer spindle and fixing screws are required (NX8/918 and SP930-308ZP). The standard Nexion Series is not suitable for fire door applications.

SL7 (Security) Australian Lock Standard (AS4145.2:2008)

D8 (Durability) Australian Lock Standard (AS4145.2:2008)

C5 (Corrosion) Australian Lock Standard (AS4145.2:2008)

CE CE Approved

C C-tick certified

Conforms to Australian Standard (AS4145.2-2008 S:7D8C5K6)

Nexion® Keyless Entry Lockset - Vision

Quick Installation

- Suitable for inward and outward opening doors of a thickness between 35–45mm. Factory set for left hand opening doors, easily changed for right hand opening doors.
- Retrofits to standard 54mm bore hole with minimal door preparation.

Range of Styles to Suit Your Home

The Nexion Keyless Entry Lockset is available in two different plate styles and a range of lever styles, allowing you to achieve a consistent style throughout your home.

Latch Dimensions

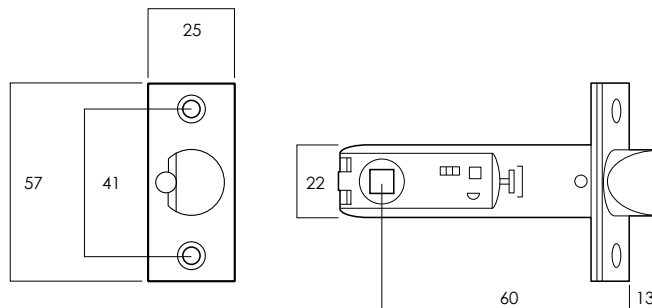

Kinetic Defence®
Bump and pick resistant.



Deadlatch Bolt
13mm projection brass bolt.



SafetyRelease™
Minimises the risk of being locked in.
Note: Applies to double cylinder locksets



2 Keys Included
Can be keyed alike to other Lockwood door locks.



Remote Access
Remote Control Locking.



Quick Installation
Suitable for door thicknesses between 35–45mm.



LockAlert®
Interior Indicator shows lock status at a glance.



Retrofiable
Fits majority of doors with 54mm hole.



Safety Mode
Securely locked from outside and free from inside.



Batteries Included



Secure Mode
Securely locked from both inside and outside. For when nobody is home.



Passage Mode
Free to enter from outside and free to exit from inside.

Nexion® Keyless Entry Lockset

Vision



Exterior



Interior

Q-Key

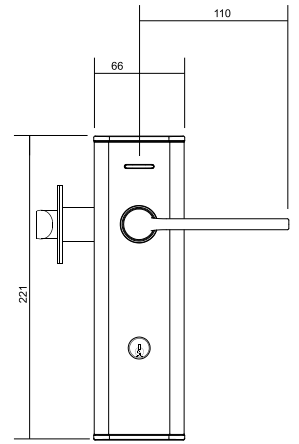
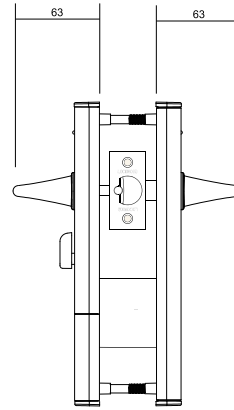
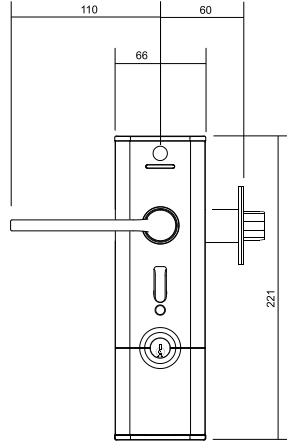

Classic



Exterior



Interior

Q-Key

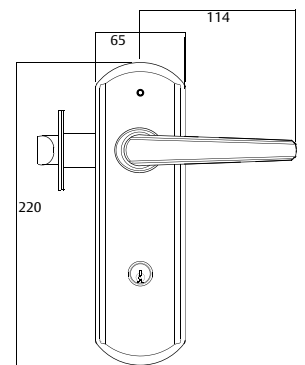
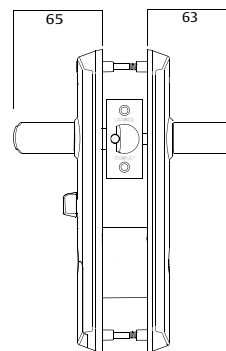
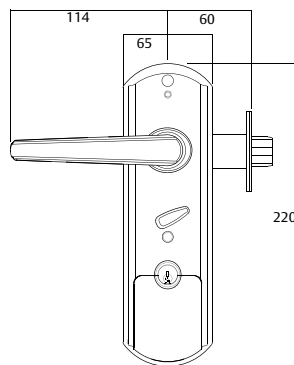

Nexion® Keyless Entry Lockset

Accessories Ordering Information

| Part Numbers | Product Description |
|---------------------|---|
| NXV8/10BLKDP | Q-Key Keyless Remote - Display Pack Only |
| NX8/20### | Rebate Kit - Trade Pack |
| NX8/20###DP | Rebate Kit - Display Pack |
| NX8/40### | Metal Frame Strike Kit - Trade Pack Only |
| NX8/70### | NX8/70 Latch (70mm Backset) - Trade Pack Only |

Note: Finishes: **GLD** Gold *Classic plate only
SC Satin Chrome #Vision plate only
SP Satin Chrome Pearl
CP Chrome Plate

Nexion Ordering Information

| Series | Function | Cylinder | Application Option | Lever/ Knob | Finish | Options |
|--------|----------|----------|--------------------|-------------|--------|---------|
| NXV | 2 | 2 | 1 | L2 | CP | 5KA |

| Series | Cylinder | Knob/Lever Style | Options |
|-------------------------------------|---------------------|------------------|---|
| Nexion Vision NXV | Dummy No Cylinder 0 | Sphere K2 | Special Keying –Residential |
| Nexion Classic NX | Single Cylinder 1 | Summit L1 | Key-Alike 5P 5KA |
| Nexion Vision Fire Rated NFV | Double Cylinder 2 | Spire L2 | Key-Alike 6P 6KA |
| Nexion Classic Fire Rated NF | | Element L3 | Project Keyed 5P 5PK |
| | | Glide L4 | Project Keyed 6P 6PK |
| | | Aria 27 | Restricted Profile 5P 5RP |
| | | Hakea 28 | For other keying options contact Lockwood Sales Office. |
| | | Acacia 29 | |
| | | Saltbrush 34 | |
| | | Mulga 36 | |
| | | Gidgee 37 | |

| Function | Application Options |
|-----------------|-----------------------|
| Mechanical 1 | Timber Frame Strike 1 |
| Keyless Entry 2 | Metal Frame Strike 3 |
| Dummy 4 | |

| Finish |
|-----------------------|
| Gold GLD* |
| Satin Chrome SC# |
| Satin Chrome Pearl SP |
| Chrome Plate CP |

* Gold finish and knob styles available with Classic plate only.
 # Satin Chrome finish available with Vision plate only.

001Touch™ Keyless Digital Deadlatch



Description

For more than seven decades Lockwood has been securing homes in Australia. Today Lockwood is proud to launch the future of keyless locking. The 001Touch™ combines a stylish digital touch screen keypad with the security of the iconic Lockwood 001® Deadlatch. The simple convenience of using a pin code means you never have to carry keys again!

Illuminated Touchscreen Keypad

The touch screen keypad has no mechanical buttons which means no trace of your secret pin code.

Pin Code or Key Card

Choose the convenience of a pin code or key card. One master pin code will manage up to twenty user pin codes. Up to 20 key cards can also be programmed.

Cryptic Code Function

Prevent others from identifying your pin code during access. The cryptic code function confuses the onlooker but at the same time allows you to still gain entry.

Product Details

| | |
|------------------------|---------------------------------|
| 001Touch Chrome | 001T-1K1CPDP |
| Backset | 60mm |
| Battery Cover | High quality ABS plastic |
| Door Thickness | 32mm to 50mm |
| Finishes | Chrome Plate (CP) |
| Keycard | RFKC10 |
| Keyfob | RFKF10 |
| Key Pad Case | High purity zinc alloy |
| Latch | Stainless steel 18mm projection |

Retrofitable

Replace your existing 001 Deadlatch™.

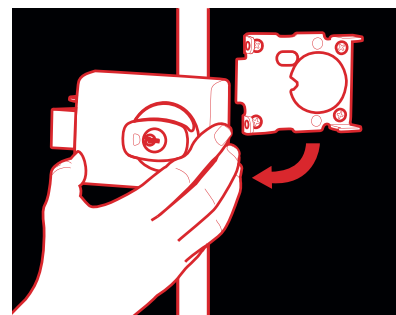

001Touch™ Keyless Digital Deadlatch

Secure Mode

Secure mode gives the option to lock the 001Touch™ internally with a key. This secures the door on both sides with the ability to unlock the door with a pin code or key card externally.

User Code that Expires

A temporary code can be programmed to last from three hours to two weeks. This is ideal when a tradesman needs access for a few hours or when a neighbour is house sitting.

Visual Guide for Programming

For added convenience, an illuminated guide will assist in the programming of key features.

Low Power Consumption

Four standard AA batteries will unlock a door up to 10,000 times. A warning light will appear when the battery level reaches less than 30%.

Battery Check Function

The battery level can be checked without removing the batteries. A simple sequence reveals the battery level between 30%–100%.

Smart Memory

The settings, codes and key cards will remain programmed in the lock in the event the batteries are depleted.

Emergency Battery Connection

The settings, codes and key cards will remain programmed in the lock in the event the batteries are depleted.

001Touch™ Keyless Digital Deadlatch



Exterior



Interior

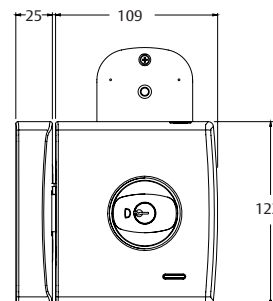
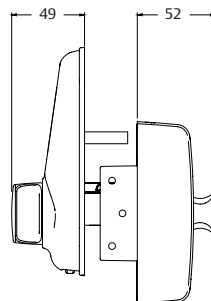
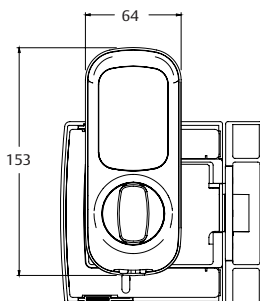

Digital Touch Screen
Illuminated keypad.



Proximity Card
2 Key Cards included.



SafetyRelease™
Minimises the risk of being locked in.



Retrofitable
Replace your existing 001 Deadlatch™.



LockAlert®
Interior Indicator shows lock status at a glance.



Emergency Battery Connection
In the event your batteries are depleted.



Safety Mode
Securely locked from outside and free from inside.



Batteries Included



Secure Mode
Securely locked from both inside and outside. For when nobody is home.



Passage Mode
Free to enter from outside and free to exit from inside.



Deadlatch Bolt
Stainless steel 18mm projection.



2 Keys Included
Can be keyed alike to other Lockwood door locks.

Keyless Digital Deadbolt



Description

No Keys? No Worries. The Lockwood Digital Deadbolt lets you unlock your front door by entering a simple code.

Ideal for use on new doors or as a replacement on an existing door lock on your home, the Keyless Digital Deadbolt is also suitable for internal and light commercial doors such as storerooms and shop fronts.

Illuminated touch screen keypad

The touch screen keypad has no mechanical buttons which means no trace of your secret pin code. One master pin code will manage up to twenty user pin codes.

Cryptic code function

Prevent others from identifying your pin code during access. The cryptic code function confuses the onlooker but at the same time allows you to still gain entry.

Visual guide for programming

For added convenience, an illuminated guide will assist in the programming of your Digital Deadbolt.

Product Details

| | |
|------------------------------------|---|
| Backset | Adjustable 60mm or 70mm |
| Back Plate | Hardened steel |
| Bolt | Zinc alloy 25mm projection |
| Description | Lockwood Keyless Digital Deadbolt Touchpad |
| External thick doors | Rubber weather resistant gasket (37mm - 50mm) |
| Finish | Powder Coated Silver (SIL) |
| Front & Back Escutcheon | High purity zinc alloy |
| Installation | 25mm latch hole and 54mm lock hole |
| Internal thin doors | Plastic gasket (32mm-36mm) |
| Part Number | LEDDB/SCYL/SIL |

Retrofittable

Fits majority of doors with 54mm hole.

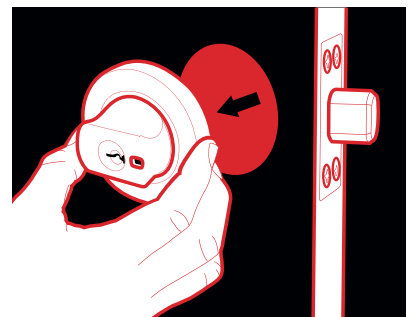

Keyless Digital Deadbolt

Low power consumption

Four AA alkaline batteries will unlock a door for approximately 12 months if used 10 times per day. A battery icon will begin flashing when the battery level reaches less than 30%.

Emergency key override

In the event your battery goes flat there is a key override function that will prevent you from being locked out.

User code that expires

A temporary pin access code can be programmed to last from three hours to two weeks. This is ideal for allowing short-term access to your property and reduces the potential risks in giving your keys to a tradesman, cleaner or neighbour.

Code lockout settings

Privacy mode allows you to deactivate the external keypad from the inside providing a secure environment from others who may have pin code access. By using your master pin, you can also restrict all user pin access.

Rebate Kit Accessories

| Part Number | Description |
|-------------|----------------------|
| 7579SSS | Universal Rebate Kit |
| 7574SSS | Strike Square Corner |

Keyless Digital Deadbolt



Exterior



Interior

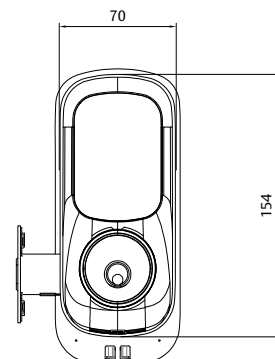
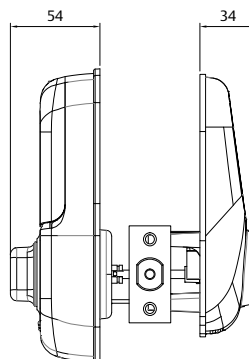
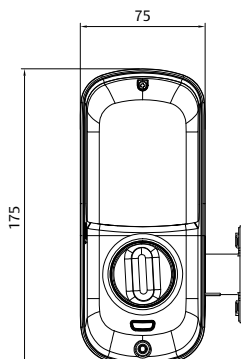

Digital Touch Screen
Illuminated keypad.



Kinetic Defence®
Bump and pick resistant.



Emergency Key Override
2 Keys Included.



Retrofitable
Fits majority of doors with
54mm hole.



Tapered Bolt
For ease of alignment to
strike.



Batteries Included

Wireless Digital Deadbolt



Description

The Lockwood Electronic Wireless Digital Deadbolt offers the flexibility of a keyless entry locking solution whilst providing wireless Z-Wave or ZigBee network connectivity to integrate into building automation solutions.

Key Features

- One touch locking
- 250 user codes (when Networked)
- Weather resistant capacitive touch path
- Key override for emergencies
- Networkable

It fits majority of doors with 54 mm hole, making it ideal for new doors or replacement for an existing door lock.

Wireless Network Connectivity

This product can be controlled remotely by web-enabled devices once it has been integrated with home/building automation systems using either the Z-Wave or ZigBee wireless network module.

Illuminated Touch Screen Keypad

The touch screen keypad has no mechanical buttons which means no trace of your secret pin code.

Product Details

| | |
|------------------------------------|---|
| Backset | Adjustable 60mm to 70mm |
| Back Plate | Hardened steel |
| Bolt | Zinc alloy 25mm projection |
| Description | Lockwood Wireless Digital Deadbolt Touchpad |
| External thick doors | Rubber weather resistant gasket (37mm - 50mm) |
| Finish | Powder Coated Silver (SIL) |
| Front & Back Escutcheon | High purity zinc alloy |
| Installation | 25mm latch hole and 54mm lock hole |
| Internal thin doors | Plasti gasket (32mm -36mm) |
| Part Number | LEDDBW/SCYL/SIL |

Retrofitable

Fits majority of doors with 54mm hole.

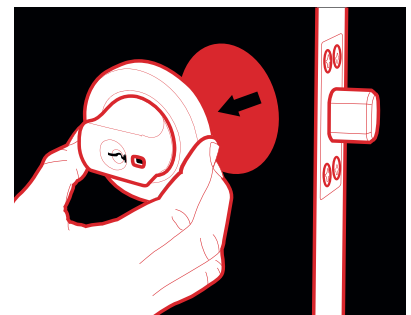



Pin Code Allowance

One master pin code will manage up to 250 user codes when used with a wireless network module or 25 user codes when not networked.

Voice Guided Programming

Voice Guided Programming will audibly provide step by step programming instructions.

One Touch Locking

Conveniently lock your door by simply touching the keypad or use the automatic locking function.

Low Battery Warning

When battery power is below 30%, the low battery icon will begin flashing.

Emergency Key Override

In the event of your battery going flat there is a key override that will prevent you from being locked out. Remember to always keep your keys in a safe and convenient place.

Tamper Alert

An audible alarm sounds if attempting to forcibly remove outside lock from door.

Automatic Re-locking

This selectable feature will automatically extend the bolt into the locking position after a 30 second delay.

Weather Resistant Keypad

What Do I Need?

| | |
|----------------------------|---|
| Building | Residential home or small business |
| Lock | Lockwood Wireless Digital Deadbolt |
| Lock Network Module | Lockwood Z-Wave or ZigBee Network Module |
| Hub | Z-Wave or ZigBee Compatible |
| Modern | Standard WIFI modem |
| Internet | Internet access via your telecommunications provider |
| Connectivity | PC, notebook, tablet or smartphone |
| Software | Home Automation Software required for PC, Notebook, Tablet or Smartphone |
| Other | Other devices to be controlled within the building need to be networked to the Z-Wave or ZigBee |

Rebate Kit Accessories

| Part Number | Description |
|-------------|----------------------|
| 7579SSS | Universal Rebate Kit |
| 7574SSS | Strike Square Corner |

Wireless Digital Deadbolt



Safety

Never Carry Keys

Keyless PIN code access ensures security whilst away and allows people entrusted with a PIN code to gain entry with the simple push of a button.

Automatic locking ensures your family and valuables are constantly protected as the door is locked after a 30 second delay when either entering or leaving the property.

Security

Resting Easy All Night Long

Privacy mode provides ease of mind by disabling the keypad to ensure that no one can enter the property from outside while you are sleeping, with the exception of close family entrusted with a key.

Remote Management

Remote Access Control

The Wireless Digital Deadbolt lock status can be viewed and controlled via a PC, Notebook, Tablet or Smartphone. Simply lock or unlock your door from anywhere in the world.

Receive a text message or email alert when the door is accessed to know that your loved ones have arrived home safely (when integrated with Remote Management Software).

Available functions may vary based on your home automation control software.

Convenience

Trigger Other Devices

Integration with Remote Management Software will enable you to turn on other devices when you open the door using your unique PIN code including:

- Unlock all doors
- Turn on the interior house lights
- Turn on the TV
- Adjusts the thermostat to 21°C
- Close the curtains

Available functions may vary based on your home automation control software.

Control

Building Automation & Integration

The Lockwood Wireless Digital Deadbolt has been designed to easily integrate with a variety of wireless building control and security systems when used with Z-Wave or ZigBee wireless network modules. Remote management puts you in control of protecting what is valuable to you from anywhere and at anytime.

User Interface Functionality

View/Change Lock Status

The lock status can viewed or changed on a Smart Phone, Tablet or PC. From anywhere in the world, remotely unlock the door for a neighbour or a caregiver.

Setup/Management

Set-up each lock and control the management of users on every door where a Lockwood Wireless Digital Deadbolt is installed.

History

View the history of who comes and goes at each door.

Trigger Other Devices

Use the lock to trigger other devices within the building such as lights, thermostat, alarm system and more.

Text/Email Alerts

Receive text or email alerts to inform who has entered the building and at what date and time.

Available functions may vary based on your home control software.

Controlling your lock from anywhere in the world

Monitoring

Control



Security



Safety



Wireless Digital Deadbolt



Exterior



Interior

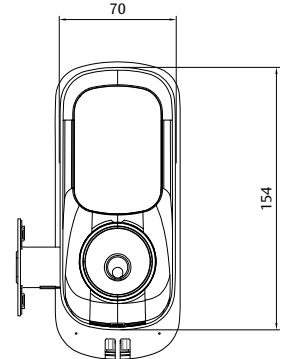
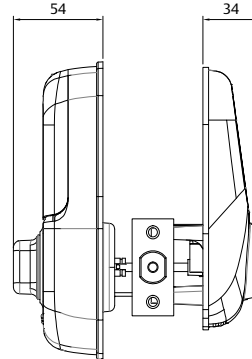
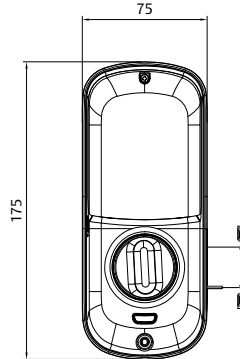

Wireless Network
Optional Z-Wave or ZigBee wireless network modules can integrate this product with building automation systems. Wireless network modules sold separately.



Digital Touch Screen
Illuminated keypad.



Kinetic Defence®
Bump and pick resistant.



Emergency Key Override
2 Keys Included.



Retrofitable
Fits majority of doors with 54mm hole.



Tapered Bolt
For ease of alignment to strike.



Batteries Included

Code Handle Keyless Lockset



Description

Lockwood's innovative door handle with integrated electronic security, offers simple and effective keyless locking, without compromising aesthetics.

Designed to enable conveniently controlled access to a door with easy installation. Code Handle is ideal for offices, store rooms or a study at home.

The Code Handle provides flexible locking options for doors that need to be always locked or alternatively can be left open to provide free access during the day and locked at night. The Code Handle is recommended for indoor use only.

Key Features

- Lever handle with integrated code lock
- Program up to 9 User codes, 4-6 digits in length
- Keypad access control lever
- Supplied with Lockwood 530 60mm latch
- Easy to install
- Ideal for retrofit installations

Product Details

| | |
|-----------------------|--|
| Backset | 60mm (70mm and 127mm latches available) |
| Door Thickness | 32 to 55mm |
| Finish | Satin Pearl with Stainless Steel (SP) (SS) |
| Installation | 25mm latch hole and 54mm lock hole |
| Latch | Brass 13mm projection deadlatch |

- Programmable administration code for setting lock operation and user programming
- Manual or automatic locking
- Passage mode
- Code lockout after 5 incorrect attempts
- Durable stainless steel handles
- Left and right handed versions

Retrofitable

Fits majority of doors with a 54mm hole. Designed to provide convenient keyless access to a door by replacing the existing door handle.

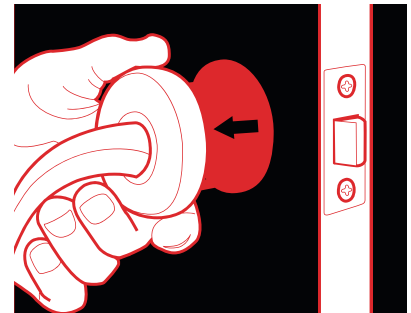

Code Handle Keyless Lockset

Code Handle Keyless Lockset



Left Hand Code Handle

8816LSS



Right Hand Code Handle

8816RSS



Exterior

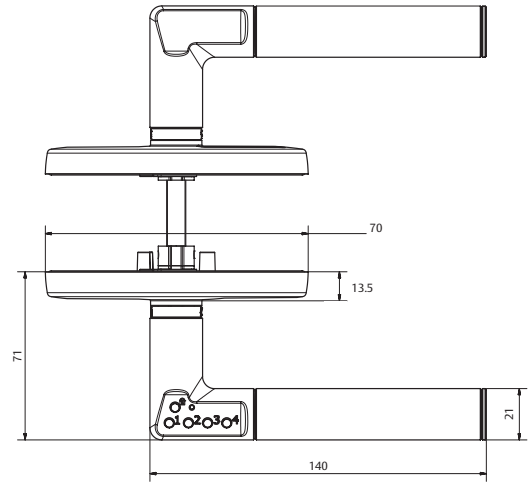

Door Thickness
32-55mm.



Quick Installation
Fitting instructions
included



Batteries Included
30,000 operations before
replacement.

002 Digital DX Deadlatch



Description

The Lockwood Digital DX Locksets provide a mechanical method of keyless entry and are designed to control access into commercial areas, especially when frequent combination changes are needed to maintain security.

For extra security when under forced attack, the inbuilt clutching mechanism allows the outside knob to rotate without operating or damaging the lock.

The factory set 5 digit code is easily changed to any 4, 5 or 6 digit code using the code changing kit provided with each lock.

As the digital lockset utilizes mechanical operation, electrical wiring is not required.

002 Digital DX Locks suit right or left suit right or left hand doors opening inward and outward.

Product Details

| | |
|-------------------------------|---|
| Backset | 60mm |
| Door Thickness | 32mm to 45mm |
| Finish | Satin Chrome Brushed* (SC) |
| Internal Case Assembly | High purity zinc alloy, 92mm wide, 72mm high, 54mm projection |
| Latch | 18mm projection, stainless steel |

* Finish denotes the finish on the digital code pad, the 002 lock body is supplied in satin chrome pearl.

Key Features

Outside Function

Press the C button, enter the correct code, then turn the knob to unlock the door. Upon releasing the turn knob the code is automatically cancelled.

Inside Function

Opened by knob/lever at all times.

Hold-Back Function

Bolt hold-back function activated by rotating inside knob/lever clockwise, past 90 degrees.

Retrofitable

Fits majority of doors with 54mm hole.

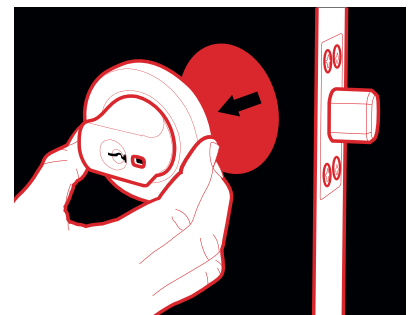

002 Digital DX Deadlatch



Exterior



Interior

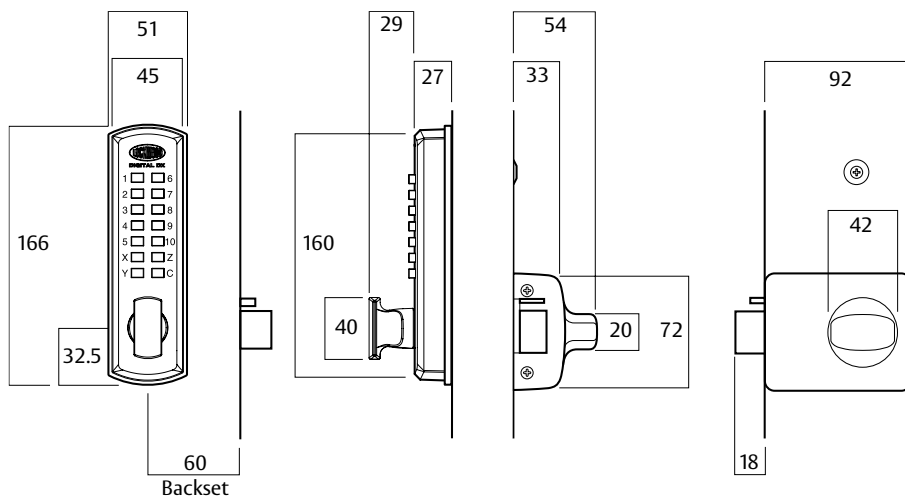

Hold Back
Bolt hold-back function activated by rotating inside knob/lever clockwise, past 90 degrees.



Fire Rated
In accordance with Australian Standard.

Rebate Kit Accessories

| Part Number | Description |
|-------------|----------------------|
| 7579SSS | Universal Rebate Kit |
| 7574SSS | Strike Square Corner |

530 Digital DX Entrance Set



Description

The Lockwood Digital DX Locksets provide a mechanical method of keyless entry.

For extra security when under forced attack, the inbuilt clutching mechanism allows the outside knob to rotate without operating or damaging the lock.

The factory set 5 digit code is easily changed to any 4, 5 or 6 digit code using the code changing kit provided with each lock.

Lockwood Digital DX Locksets are designed to control access into commercial areas, especially when frequent combination changes are needed to maintain security.

As the digital lockset utilizes mechanical operation, electrical wiring is not required.

530 Digital DX Locks suit right or left hand doors opening inward and outward.

Product Details

| | |
|-----------------------|---|
| Backset | 60mm, 70mm and 1277mm latches available separately on application |
| Door Thickness | 32mm to 45mm |
| Finishes | Satin Chrome Brushed (SC) Polished Brass (PB) |
| Latch | Brass 13mm projection deadlatch |

* Options: Also available in double keypad version, which provides a keypad on each side of the door.

Key Features

Outside function

Press the C button, enter the correct code, then turn the knob to unlock the door. Upon releasing the turn knob the code is automatically cancelled.

Inside function

Opened by knob/lever at all times.

530 Digital DX Entrance Set



Interior Exterior

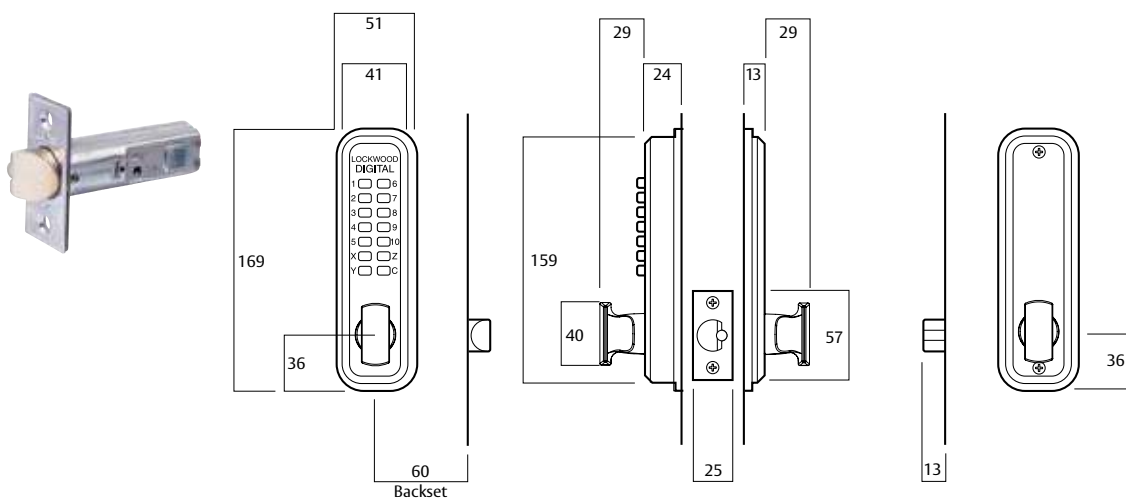

Fire Rated
In accordance with
Australian Standard.

Mortice Digital DX Lockset



Description

The Lockwood Digital DX Locksets provide a mechanical method of keyless entry and are designed to control access into commercial areas, especially when frequent combination changes are needed to maintain security.

For extra security when under forced attack, the inbuilt clutching mechanism allows the outside knob to rotate without operating or damaging the lock.

The factory set 5 digit code is easily changed to any 4, 5 or 6 digit code using the code changing kit provided with each lock.

As the digital lockset utilizes mechanical operation, electrical wiring is not required.

Combination of 3572 Series Cylinder Mortice Locks suit right or left hand doors opening inwards.

Product Details

| | |
|-------------------------------|--|
| Backset | 60mm |
| Door Thickness | 32mm to 50mm |
| Finish | Satin Chrome Brushed* (SC) |
| Internal Case Assembly | High purity zinc alloy, 92mm wide,, 72mm high, 54mm projection |
| Latch | 18mm projection, stainless steel |

* Options: Also available in double keypad version, which provides a keypad on each side of the door. Extended backsets 89mm and 127mm on application. Door Furniture Lockwood 1800 and 2800 Series (ordered separately).

Key Features

Outside Function

Press the C button, enter the correct code, then turn the knob to unlock the door. Upon releasing the turn knob the code is automatically cancelled.

Inside Function

By lever handle or knob at all times.

Hold-Back Function

A key operated hold-back function is available upon request. This is achieved by a pin tumbler cylinder on the inside allowing the bolt to be held back.

Mortice Digital DX Lockset



Exterior



Interior

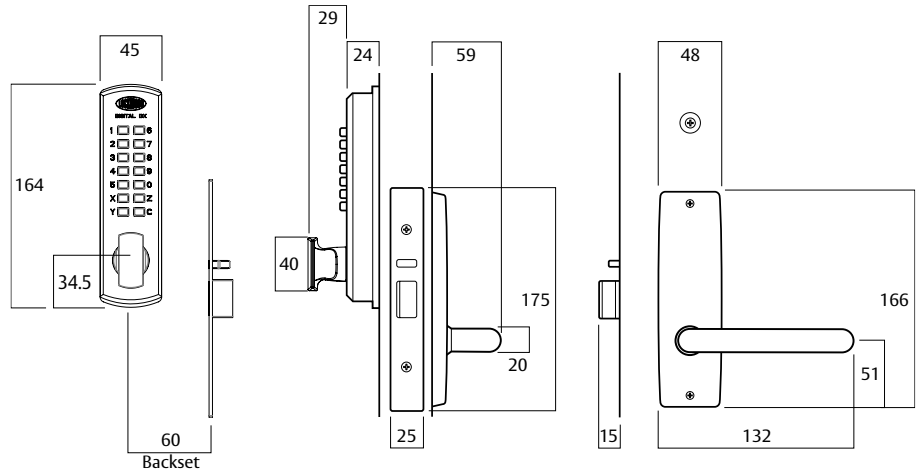

Backset



Fire Rated
In accordance with
Australian Standard.

3582, 3592 Short Backset Digital DX Lockset



Description

The Lockwood Digital DX Locksets provide a mechanical method of keyless entry.

For extra security when under forced attack, the inbuilt clutching mechanism allows the outside knob to rotate without operating or damaging the lock.

The factory set 5 digit code is easily changed to any 4, 5 or 6 digit code using the code changing kit provided with each lock.

Lockwood Digital DX Locksets are designed to control access into commercial areas, especially when frequent combination changes are needed to maintain security.

As the digital lockset utilizes mechanical operation, electrical wiring is not required.

Combination of 3582 Series Short Backset Cylinder Mortice Lock suit right or left hand doors opening inward and outward.

Product Details

| | |
|-------------------------------|---|
| Backset | 60mm |
| Door Thickness | 32 to 50mm for timber doors. 35 to 50mm for metal doors |
| Finish | Satin Chrome Brushed* (SC) |
| Internal Case Assembly | High purity zinc alloy, 92mm wide, 72mm high, 54mm projection |
| Latch | 18mm projection, stainless steel |

* Options: Also available in double keypad version, which provides a keypad on each side of the door. Note: As suitability of lever will be influenced by the lock backset, refer to chart for Lever/Backset compatibility Lockwood Door Handle Catalogue. Lockwood 4800 and 5800 Series (ordered separately).

Key Features

Backset
Open-out door: 23, 25.4, 30 and 38mm. Open-in door: 38mm recommended. Installation of 23, 25.4 or 30mm on open-in doors would require the door stop to be machined to clear the digital pad.

Inside Function

Opened by knob/lever at all times.

3582, 3592 Short Backset Digital DX Lockset



Exterior



Interior

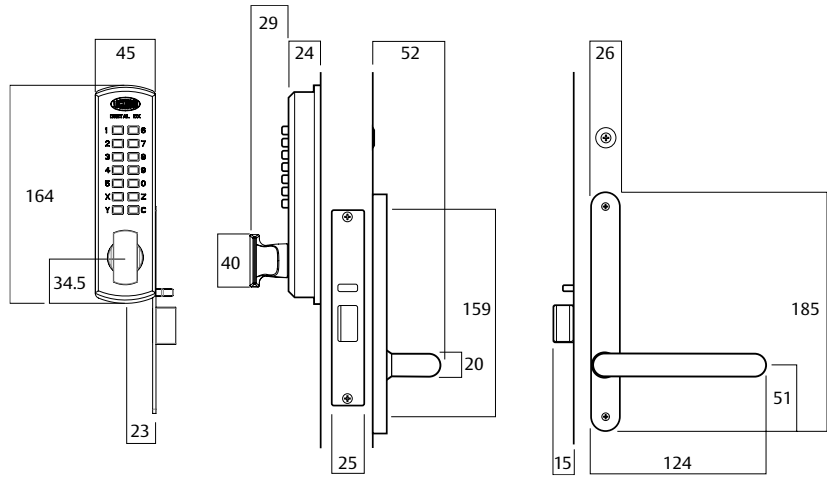

Fire Rated
In accordance with
Australian Standard.

3572 Key Override Digital DX Lockset



Description

The Lockwood Digital DX Locksets provide a mechanical method of keyless entry and are designed to control access into commercial areas, especially when frequent combination changes are needed to maintain security.

For extra security when under forced attack, the inbuilt clutching mechanism allows the outside knob to rotate without operating or damaging the lock.

The factory set 5 digit code is easily changed to any 4, 5 or 6 digit code using the code changing kit provided with each lock.

As the digital lockset utilizes mechanical operation, electrical wiring is not required.

Combination of 3572 Series Cylinder Mortice Locks suit right or left hand doors opening inwards.

Key Features

Outside Function

Outside: Press the C button, enter the correct code, then turn the knob to unlock the door. Upon releasing the turn knob the code is automatically cancelled. The key override pin

Product Details

| | |
|-----------------------|---|
| Backset | 60mm |
| Cylinder | Pin tumbler mechanism with round brass cylinder |
| Door Thickness | 35mm to 50mm |
| Finish | Satin Chrome Brushed* (SC) |
| Lock Assembly | 3572 Series Cylinder Mortice Deadlatch |

* Extended backsets 89 and 127mm on application. For furniture to suit 3572 Series Locksets select from Lockwood 1800 and 2800 Series. (ordered separately).

tumbler cylinder enables quick access by key for authorities such as the fire brigade or those who need to carry a master key to access all rooms of a building. Inside: By lever handle or knob at all times.

Inside Function

By lever handle or knob at all times.

Hold-Back Function

A key operated hold-back function is available. This is achieved by a pin tumbler cylinder on the inside allowing the bolt to be held back. Will also require change to internal furniture plate.

Restricted Special Keying

Lockwood locks can be keyed to a number of controlled and/or specially

keyed systems. These range from legally protected keys to protect against unauthorised duplication, which can also include specially designed key systems such as master key systems, which allow for different levels of mechanical access control.

Please refer to Lockwood Catalogue Cylinders & Keying for keying systems or contact your local sales office or customer service for specific information.

Standard Keying

- Supplied individually keyed with two keys per lock
- 78,000 key combinations
- Key blank KB2015P

3572 Key Override Digital DX Lockset



Exterior



Interior

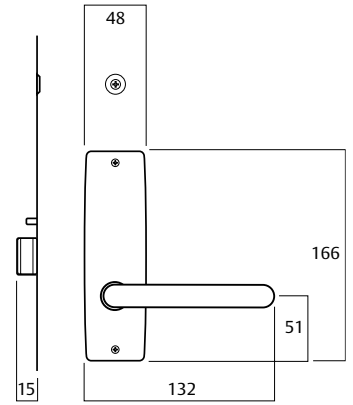
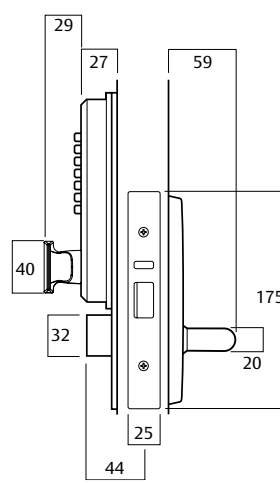
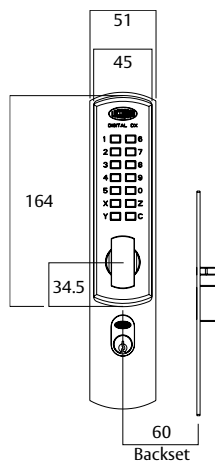

Fire Rated
In accordance with
Australian Standard.

3572 Key Override Code Lockout Digital DX



Description

The Lockwood Digital DX Locksets provide a mechanical method of keyless entry and are designed to control access into commercial areas, especially when frequent combination changes are needed to maintain security.

For extra security when under forced attack, the inbuilt clutching mechanism allows the outside knob to rotate without operating or damaging the lock.

The factory set 5 digit code is easily changed to any 4, 5 or 6 digit code using the code changing kit provided with each lock.

As the digital lockset utilizes mechanical operation, electrical wiring is not required.

Combination of 3572 Series Cylinder Mortice Locks suit right or left hand doors opening inwards.

Key Features

Outside Function

Outside: Press the C button, enter the correct code, then turn the knob to unlock the door. Upon releasing the turn knob the code is automatically cancelled. The key override pin tumbler cylinder enables quick access

Product Details

| | |
|-----------------------|---|
| Backset | 60mm |
| Cylinder | Pin tumbler mechanism with round brass cylinder outside, oval cylinder inside |
| Door Thickness | 32mm to 50mm |
| Finish | Satin Chrome Brushed* (SC) |
| Lock Assembly | 3572 Series Cylinder Mortice Lockset |

* For door furniture to suit 3572 Series Locksets select from Lockwood 1800 and 2800 Series. (ordered separately).

by key for authorities such as the fire brigade or those who need to carry a master key to access all rooms of a building. In addition, an interior pin tumbler lockout cylinder is fitted.

Inside Function

Inside: By lever handle or knob at all times. The lockout cylinder enables the digital function to be made inoperative, allowing for key entry only during certain times of the day or after hours.

Keying

Standard Keying

- Supplied individually keyed with two keys per lock
- 78,000 key combinations
- Key blank KB2015P

Restricted Special Keying

Lockwood locks can be keyed to a number of controlled and/or specially keyed systems. These range from legally protected keys to protect against unauthorised duplication, which can also include specially designed key systems such as master key systems, which allow for different levels of mechanical access control.

Please refer to Lockwood Catalogue Cylinders & Keying for keying systems or contact your local sales office or customer service for specific information.

3572 Key Override Code Lockout Digital DX

Hold-Back Cylinder

Special cylinders with levers that enable the latchbolt to be held in the retracted position. This cylinder type hold-back can only be applied or released by the key. These special cylinders are available on application and are supplied handed to suit lock function. Can only be installed to internal side of digital 3572 Locks.

Standard Finishes

Satin Chrome Brushed **SC**

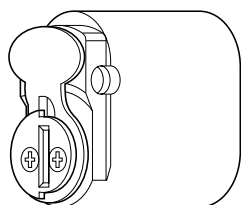

Rebate Kits

Rebate kits suit standard 13mm rebate.

Standard Finishes

Satin Chrome Brushed **SC**

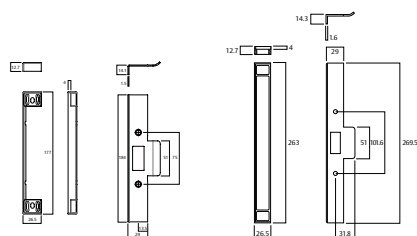

3570 Series

3580 Series

Short/Extended Lipped Strikes

Standard Finishes

Satin Chrome Brushed **SC**

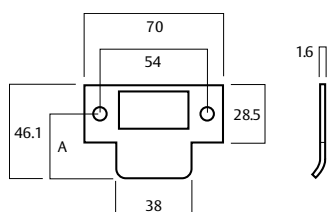

Handing

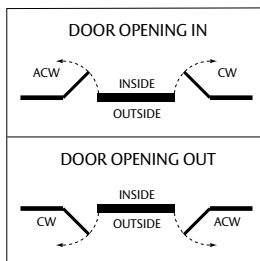

CW (Clockwise)

Left Hand open in and Right Hand open out.

ACW (Anti-Clockwise)

Left Hand open out and Right Hand open in.

3570 and 3580 Series Locks

| Finish | (A) | Part Number |
|-------------------|--------|----------------|
| SSS | 25.4mm | SP3570-4053SSS |
| SSS | 32mm | SP3570-5053SSS |
| SSS | 43.5mm | SP3570-5253SSS |
| SSS | 47.5mm | SP3570-5453SSS |
| 530 Series | | |
| SC | 40mm | SP530-153SC |

Part Numbers

| Series | Right Hand | Left Hand |
|-------------------|---------------|---------------|
| 3570 Locks | SP3570-2402SC | SP3570-2452SC |
| 3580 Locks | SP3580-2402SC | SP3580-2452SC |

* To order, add finish to part number eg. 3570-2402CP

Rebate Kit Part Numbers

| Series | Part Numbers |
|-------------|---|
| 3570 | 3P72-RK32SS |
| 3580 | 3580-2902 CWSC—Clockwise 3580-2902ACWSC—Anti-Clockwise |

3572 Key Override Code Lockout Digital DX



Exterior



Interior

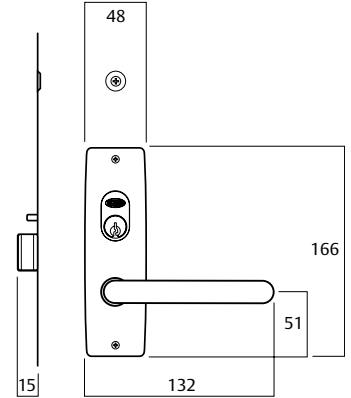
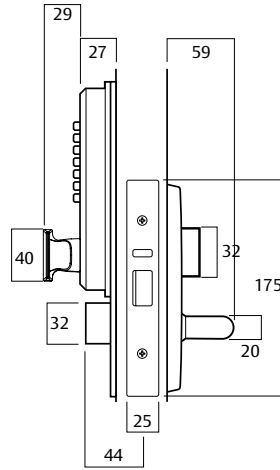
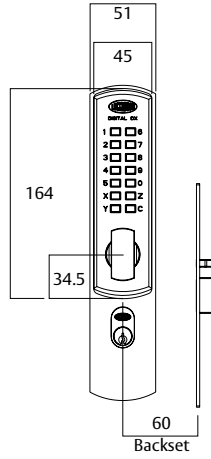

Fire Rated
In accordance with
Australian Standard.

3572 Key Override Code Lockout Digital DX

Ordering Procedure

Sample part number 3572DXKORSC is made up of several sections. Choose your product by selecting an option from each section.

Mortice Digital DX Locks Ordering Procedure

| Product | Function | Special Spec. | Handing | Finish | Special Functions |
|---------|----------|---------------|---------|--------|-------------------|
| 3 | 572DX | KO | R | SC | |

| Product | Special Specification | Finish |
|--------------------|-----------------------|-------------------------|
| 60mm | None | Satin Chrome Brushed SC |
| 89mm | Key Override KO | |
| 127mm | Code Lockout CLO | |
| Short Backset 23mm | | |
| 25.4mm | | |
| 30mm | | |
| 38mm | | |

| Handing | Finish |
|----------------|-----------------------|
| Right Handed R | None |
| Left Handed L | Double Keypad* /PADS2 |

* Double keypad version available 530 variations in trade pack only

| Function | Special Functions |
|--|-------------------|
| Mortice Lock 572DX | |
| Short Backset Mortice Lock (Metal Door) 572DX | |
| Short Backset Mortice Lock (Timber Door) 592DX | |

002/530 Digital DX Ordering Procedure

| Hardware Code | Keypad Code | Finish | Packaging | Special Functions |
|---------------|-------------|--------|-----------|-------------------|
| 530 | DX | PB | DP | |

| Hardware Code | Keypad Code | Finish | Packaging | Special Functions |
|---|---------------|-----------------------|--------------------|---|
| 530 Latch Plate 530 | Digital DX DX | Polished Brass* PB | Polished Brass* DP | None |
| 002 Deadlatch Knob Timber Frame 002-1K | | Satin Chrome Pearl 56 | Trade Pack - | Double Keypad /PADSX2 |
| 002 Deadlatch Knob Metal Frame 002-3K | | * 530 Variations only | | * Double keypad version available 530 variations in trade pack only |
| 002 Deadlatch Knob Open Out 002-4K | | | | |
| 002 Deadlatch Lever Timber Frame 002-1L | | | | |
| 002 Deadlatch Lever Metal Frame 002-3L | | | | |
| 002 Deadlatch Lever Open Out 002-4L | | | | |



ASSA ABLOY

Lockwood is the leading brand in the Australian locking industry. With an established reputation for high quality products, this iconic brand provides a wide range of locking solutions to residential housing, commercial building and industrial application markets. Lockwood is supported by an extensive distribution and after-sales support network. Our customers include retailers, architects, trade and industrial personnel, locksmiths and security dealers.

ASSA ABLOY is the global leader in door opening solutions, dedicated to satisfying end-user needs for security, safety and convenience.

ASSA ABLOY is represented in all major regions, in both mature and emerging markets, with leading positions in Australia, Europe and North America.

25YEAR

**MECHANICAL
WARRANTY**

The Lockwood 25 Year Mechanical Warranty

Our belief that we manufacture the finest premium products available in today's market place is backed by the Lockwood 25 Year Mechanical Warranty, ensuring that Lockwood continues to keep Australians safe by delivering security and peace of mind.

For warranty terms and conditions, please visit www.lockweb.com.au or call 1300WARRANTY

ASSA ABLOY Australia Pty Ltd
235 Huntingdale Road
Oakleigh, Victoria, 3166
Australia

1300 LOCK UP (1300 562 587)
lockweb.com.au

ASSA ABLOY New Zealand Ltd
6 Armstrong Road
Albany, Auckland, 0632
New Zealand

info.nz@assaabloy.com
Telephone +64 9415 7111
assaabloy.co.nz



Aus Lock & Safe Company

Factory 16, 47-51 Little Boundary Road,
Laverton North VIC 3026

1800 AUS LOCK (287 562)
<http://auslock.com.au>